

WT-XS2

Voice Prompter (Radar Induction)



1. Product introduction

Welcome to use Waytronic products. This product adopts radar detection and motion induction technology and the detection distance is accurate to the centimeter level. When a person or object passes through the induction area, it will immediately broadcast the voice. The appearance and operation is simple and convenient. You can adjust the volume, set the timing, and change the voice through the WeChat applet. Built-in lithium battery, low power consumption design, suitable for the application that require a very precisely detection, such as: parking lot entrance and exit, toilet, warehouse height limitation, elevator counterweight alarm and other places.

2. Product features

- PIR Infrared and radar detection and induction technology, strong anti-interference and stable performance.
- Radar detection sensor, support set detect distance.
- Built-in lithium battery, support charging management.
- 2W speaker, loud and strong sound.
- Sound can be recording via Bluetooth and USB connected with computer.
- The WeChat applet supports functions such as timing settings and power-saving mode activation.

3. Electrical parameters

Power Supply	DC5V 1A	
	Built in 1000MA lithium battery	
Working Current	Sleep standby mode	≤30mA
	Sleep standby mode (Power saving mode)	≤45uA
	Playing mode	≤325mA
	Charging	≤900mA
Audio Format	MP3	Bit Rate: 16~320Kbps
Audio Output Power	8Ω/2W(typical value)	
Volume	≥100dB	
Induction Range	30-350±20CM	
Working temperature	- 20-33℃	
Battery lasting time	In fully charged state, playing 50 times a day, 10 seconds long voice, battery can last more than a month	

4. Appearance introduction

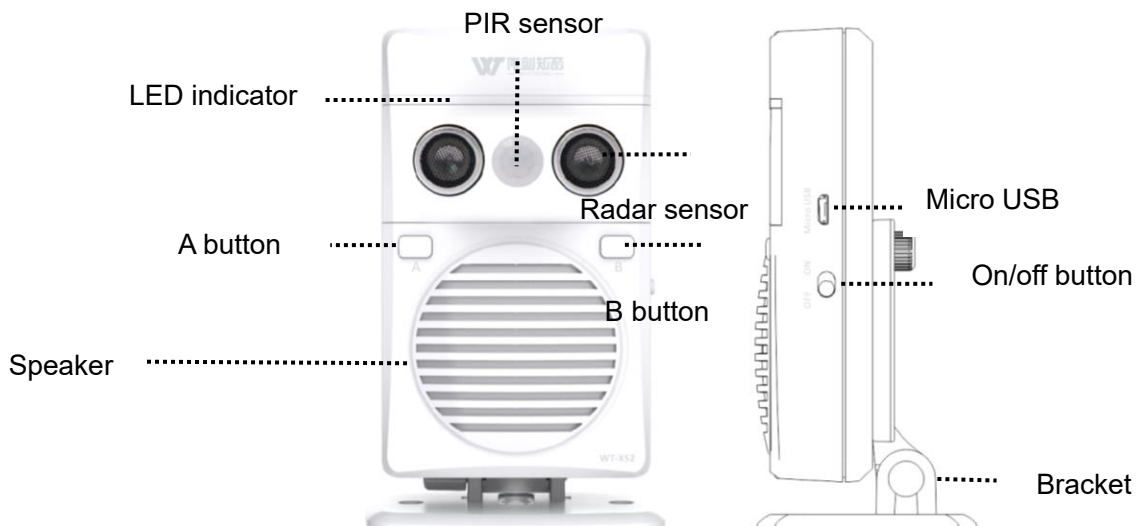

4.1 Button function

Button name	Operation	Function
A Button	Short press	Next audio (all loop)
	Long press 3 seconds	Press and hold for 3 seconds to automatically start learning distance when aiming at the learning target. At the same time, the red indicator light flashes. If the learning is successful, it will play "Successful learning", if learning unsuccessful, it will play "Learning failed"
	Short press 3 times	Switch to single playing mode/all loop playing mode
B Button	Short press	Volume adjustment(7 levels)
	Long press 3 seconds	Open Bluetooth to recording sound
A&B Button	Long press 3 seconds together	Delete the last voice file

5.Audio download

5.1 Change audio via USB

- ① Connect the computer via the micro USB data cable, and recognize the removable disk.
- ② Copy the prepared MP3 voice to the removable disk.
- ③ Disconnect the data cable, short press the A button to listen the audio.

5.2 Upload audio via mobile phone Bluetooth

- ① Long press B button to open the Bluetooth and use the mobile phone to search for the connection, the Bluetooth name is "WT-XS2".
- ② Audio will record automatically when phone playing.
- ③ After recording, press the "didi" twice and then exit audio record

6. Wechat app application



Download wechat app then scan the QR code

6.1 How to connect the Mini program

- ① Open the mobile phone's Bluetooth and mobile phone positioning, scan the QR code and connect.
- ② Click "Search for the device", you will see "LE-XS2" connect and enter password"000000"

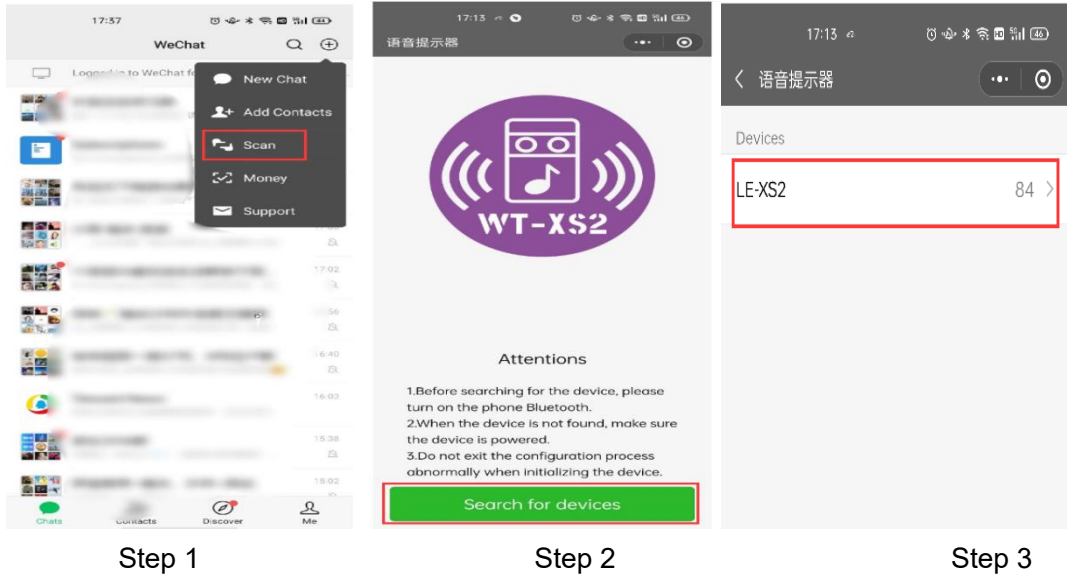

6.2 How to choose the mode

"Infrared human body sensing trigger" is turned on for power saving mode, and turned off for radar mode (the radar does not sleep, and the object keeps playing voice in the sensing range).

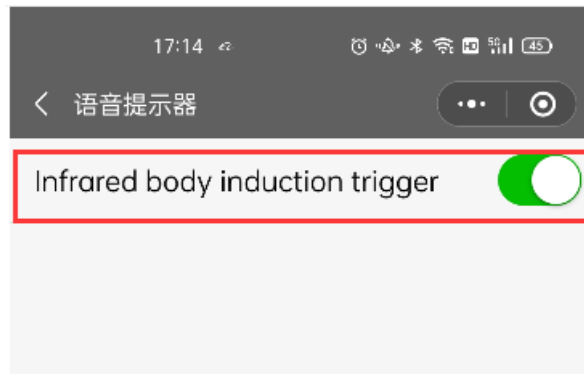

Valid when there is no timing setting

6.3 How to listen to the unit audio

- (1) Music listening, click the button to play or pause the voice.
- (2) Click the and button to select and listen the voice.
- 3) Slide the to adjust the sound level.

6.4 How to set timing setting

(1) Timing setting: Click "Timed Play" to enter the interface, On this interface, you can select the playing date, music (including tracks/all loops, sound size), and start/end time.

① Select the "Custom", it means the selected sound will play once during the set time period.

② Select "All Loop", it means the selected sound will play in sequence after each trigger.

(2) Save the settings: After the settings are completed, click "OK" in the upper right corner to automatically return to the "Timing" interface, and click "Settings Synchronization" at the bottom of the "Timing" interface to complete the settings.

Note: Timed playback supports up to 20 groups

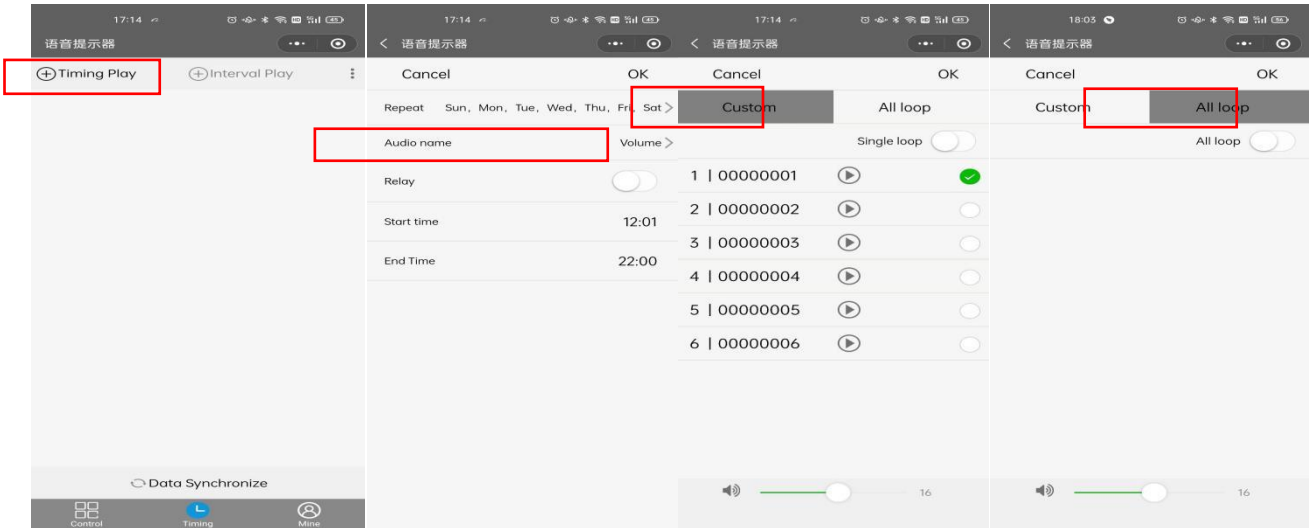

Step 1

Step 2

Step 3

Step 4

(2) Save the settings: After the settings are completed, click "OK" in the upper right corner to automatically return to the "Timing" interface, and click "Settings Synchronization" at the bottom of the "Timing" interface to complete the settings.

(3) Save the settings in batches: Click the hidden button in the upper right corner of the timing interface and select "Data Storage". After connecting to another product, click the "Get Archive" to call up the timing group, then click "Set Synchronization".

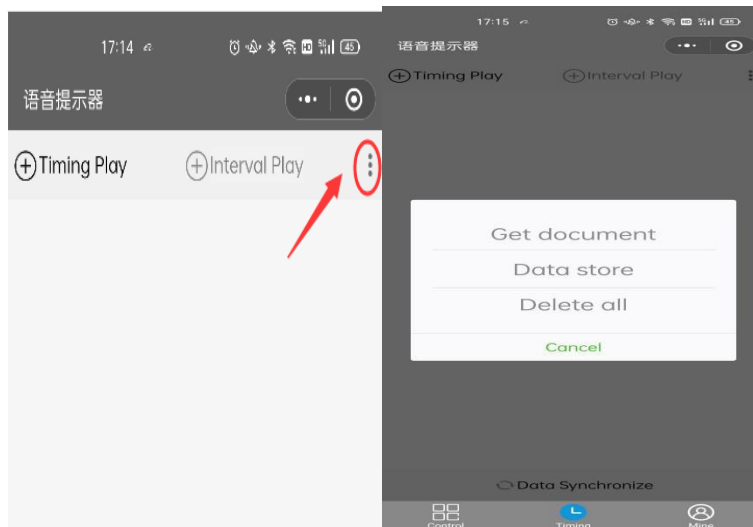

Step 1

Step 2

(4) Batch delete timing setting: Click "Batch Delete" in the hide button to delete the timing group.

6.5 Change Bluetooth name and password

Click on the "Mine" page to enter "Parameter Settings", enter "Bluetooth Name" and modify the login password.

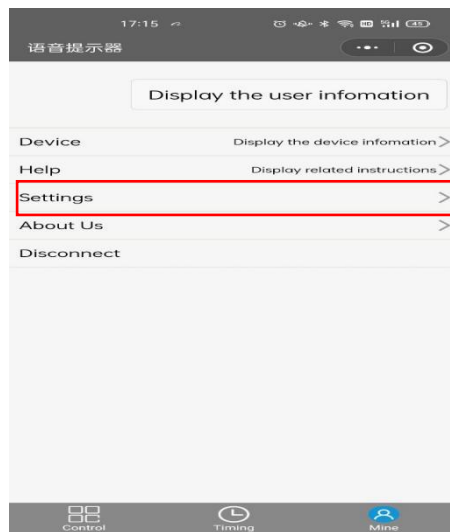

Note: After the setting is completed, turn off the Bluetooth to enter the set working mode.

7. Installation

7.1 Bracket assembly

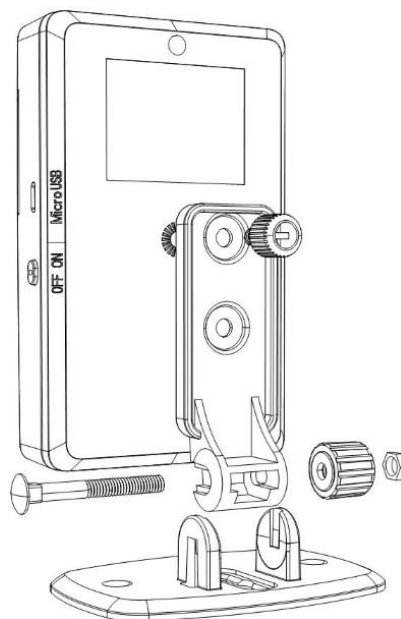

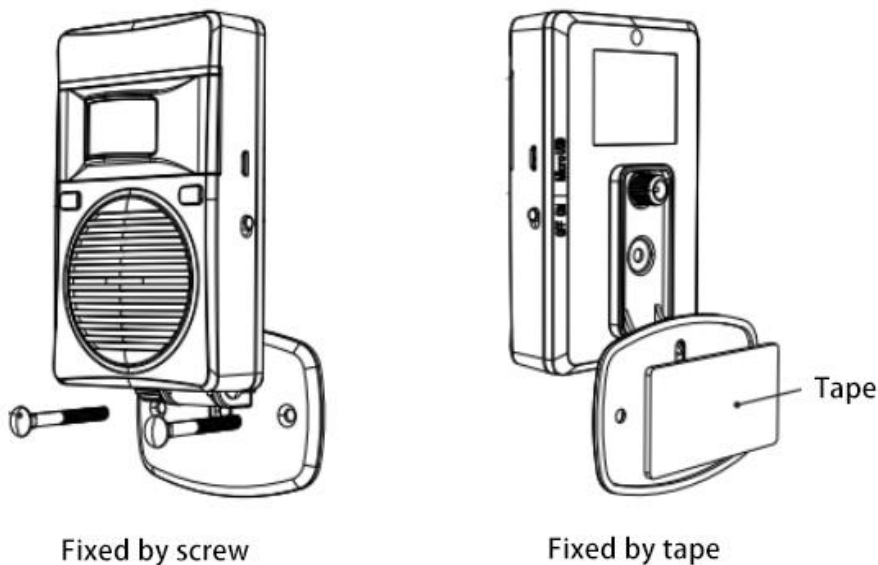

7.2 Installation Precautions

(1) Radar detect angle is 0.3-3.5 meters length and 1.2 meters width. If the distance is exceeded, the sensing will not be set and the voice will be triggered, as shown in the figure below.

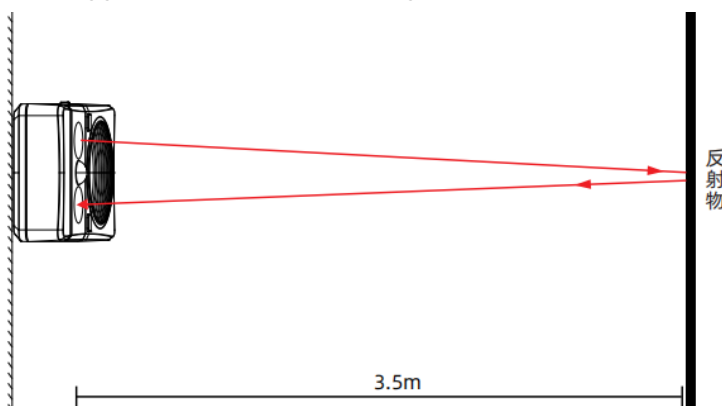

(2) How to wake up ultrasound to working: when people passes through the sensing area (as shown in the figure below), the voice is triggered when entering the set distance of the radar (the infrared sensing angle is 120°, and it is effective when passing through from the left and right sides. Wake up ultrasound to enter working mode).

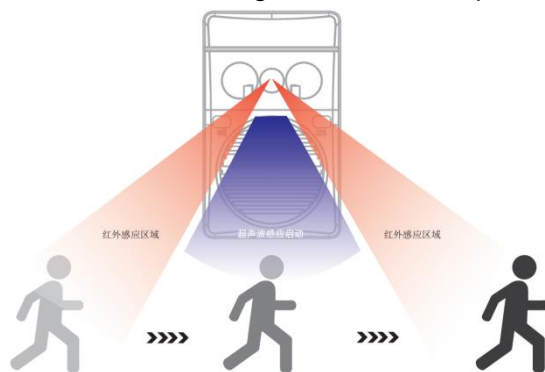

(3) There should be no other similar products around the product, such as reversing radar, to avoid false trigger.

8.FAQ

Problem	Solution
No reaction when turn on, sound intermittent sound	Please confirm whether the battery is in a low power state, please charge or replace the battery in time
Sensing distance is too short	1. Please confirm whether it is in power saving mode. 2. Please confirm whether it is installed in accordance with the requirements of the installation.
Misplay	1. Are there obstacles in the sensing area of the product? 2. Whether there are interference sources around the product (like radar products).
The applet cannot search for Bluetooth	1. Please make sure that the mobile phone turns on Bluetooth, positioning and network. 2. Press the key to wake up the Bluetooth. 3. Exit the applet and reopen it and click search.

9. Accessories

Name	Quantity
Host	1 pcs
Bracket	1 set
5V 1A USB adapter	1 pcs
USB cable	1 pcs
User manual	1 pcs

Disclaimer

Shenzhen Waytronic Electronics Co., Ltd. reserves the right to modify the use of materials without notifying customers. The new product specifications will be subject to the latest version of the usage data.

Contact Us

Shenzhen Waytronic Electronics Co., Ltd.

Tel: +86-755-29605099

Fax : +86-755-29606626

Website: <https://www.waytronicmfg.com/>

E-mail: info@waytronicmfg.com

Add:4/F,Building No.11,Fuan Robotics Industrial Park, Fuyong,Baoan District,Shenzhen ,518103,Guangdong ,China